



# Bluehelix Tech

Wall-hung premix condensing boilers, only heating or instant combi operation

**ferrol**

## > EFFICIENT, RATIONAL & ROBUST CONSTRUCTION



Range of BLUEHELIX TECH boilers is equipped with exchanger in stainless steel AISI 316 TI, developed by Ferrol's R & D. The generator has been designed and constructed according to ErP regulation on eco-compatible design and labelling. BLUEHELIX TECH achieves among the highest heating seasonal efficiency ratio of its category in the market, i.e.  $\eta_s$  94%<sup>(\*)</sup>. Furthermore, the combination with an outdoor probe and Romeo remote control, constitutes an heating package, marked with A+ system energy label.

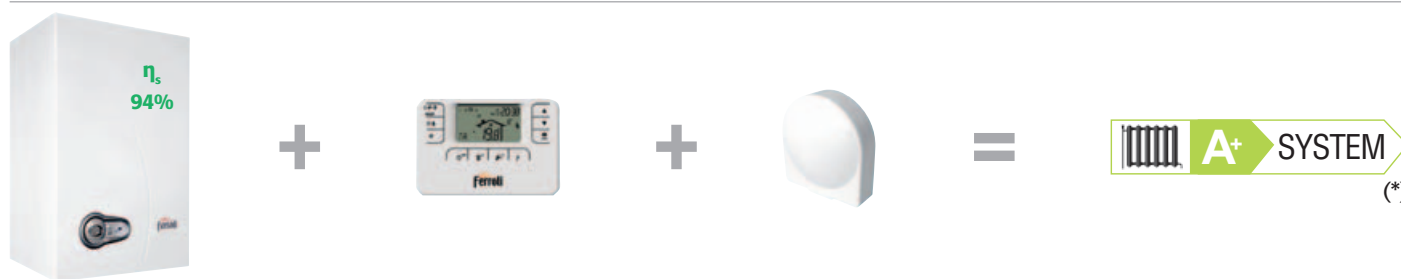

Ferrol boiler

Romeo

Outdoor probe

A+ energy label for the heating package

<sup>(\*)</sup>except mod. 18 A / 45 H

## > THE RANGE

Operation on either natural gas or LPG

### mod. 25C

FOR CENTRAL HEATING AND INSTANT DOMESTIC HOT WATER PRODUCTION  
HEAT INPUT 27,5 kW  
DHW 15,5 l/min at  $\Delta T$  25°C

### mod. 35C

FOR CENTRAL HEATING AND INSTANT DOMESTIC HOT WATER PRODUCTION  
HEAT INPUT 34,8 kW  
DHW 19,5 l/min at  $\Delta T$  25°C

### mod. 18A

HEATING ONLY  
HEAT INPUT 17,4 kW

### mod. 25A

HEATING ONLY  
HEAT INPUT 25 kW

### mod. 35A

HEATING ONLY  
HEAT INPUT 34,8 kW

### mod. 45H

HEATING ONLY  
HEAT INPUT 43 kW

## > FEATURES PRODUCT PLUSES

- > **Boiler body** with new primary heat exchanger, made from thick AISI 316 Ti stainless steel
- > **Only heating model (A)** is pre-equipped with diverting valve for connection to a **free standing DHW storage tank** (except model 45H)
- > **Instant Combi model includes** dedicated domestic hot water **plate heat exchanger**
- > **Stainless steel total premix burner**
- > Can be operated using the **modulating remote timer control**. Connection with an additional device (on/off room thermostat type) can be enabled.
- > **Modulating high-efficiency central heating pump (Erp-ready – class A)**
- > **ECO function:** higher saving when DHW is not necessary (also programmable through Romeo remote control)
- > **3-star comfort** for domestic hot water production, certified in accordance with EN 13203, amended by Reg. 812/2013 (mod C)
- > **Temperature compensation** based on optional outside probe reading
- > **Extra functions: programmable legionella protection** (in case of cylinder connection), **boiler frost protection program** (if gas supplied and powered in stand-by mode)
- > **Connection to solar heating systems:** ready for domestic hot water production in combination with solar collectors system (mod C)
- > **Hydraulic By-pass** as standard (except mod. 45H)
- > **Place of installation:** outdoor installation in partially protected places down to -5°C as standard and down to -15°C when using the optional frost protection heater kit
- > **Model 45 H (heating)** consists in a compact heating only generator. It is electronically preset for a connection to a domestic hot water cylinder (3 way valve not supplied). Expansion vessel needs to be sized according to heating system requirements
- > **Seasonal efficiency:  $\eta_s$  94%, i.e. among the highest in the market** (mod. 25-35)
- > : **Romeo and outdoor probe**, combined with a **Ferrol boiler** with seasonal efficiency  $\eta_s \geq 94\%$ , constitutes a system marked with **A+ energy label** in heating operation (except mod. 18A - 45H)

## > PRODUCT IN PILLS



94% as seasonal efficiency in heating ( $\eta_s$ ) according to Reg. 811/2013

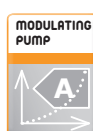

Includes modulating pump - class A efficiency - **ERP compliant**



Possible connection to an optional outdoor probe, thus enabling **system flow temperature compensation**



Settable function keeping the exchanger warm, thus granting **ultra-prompt supply of DHW**



The appliance can be combined with **domestic hot water pre-heating systems (mod. C)**



Appliance rated as **class 5**, the most **ecological** rating defined the relevant European standards (EN 297 and 483)



**Modulating remote control (ROMEO)** for setting boiler parameters



High performance, **primary heat exchanger** made from AISI 316 Ti stainless steel



Ingress **Protection X5D**: indicates excellent protection against liquid and solid intrusion to boiler's enclosure

## > PERFORMANCES ENERGY LABELLING

The **"20-20-20 Climate-Energy Package"** envisages ambitious targets in reducing greenhouse gas emissions and energy requirements, along with increase of renewable energy use, everything in a measure of 20%, to be reached within 2020. The European regulation **ErP** (Energy related Products) , also made for this scope, introduces an energy rating also for hot water generator, used for central heating of domestic hot water preparation.

Such rating implies **an energy label**, which must be associated with any product affected by the regulation, introduced in the market **since 26th september 2015**.

Energy labelling, as occurred in the household appliance field, becomes then an easy guide for consumer. He will be able indeed to decide the most efficient product, by means of standardized and objective indications. As a consequence, user's choice will be the most cheap in consumption for user, but also the most virtuous for environmental balance.

Most important parameters shown on labels are seasonal efficiency index in heating and eventual efficiency index in production of domestic hot water. For individual boilers the parameters are expressed in a range decreasing from A to G. Higher rating can be reached through a combination boiler + renewable energy products. Moreover combi boilers are rated a tapping profile. It corresponds to a constant DHW rate, measured in different kind of water withdrawals, granting at least declared sanitary efficiency. Tapping profile is indicated with a letter / size (S, M...XXL).

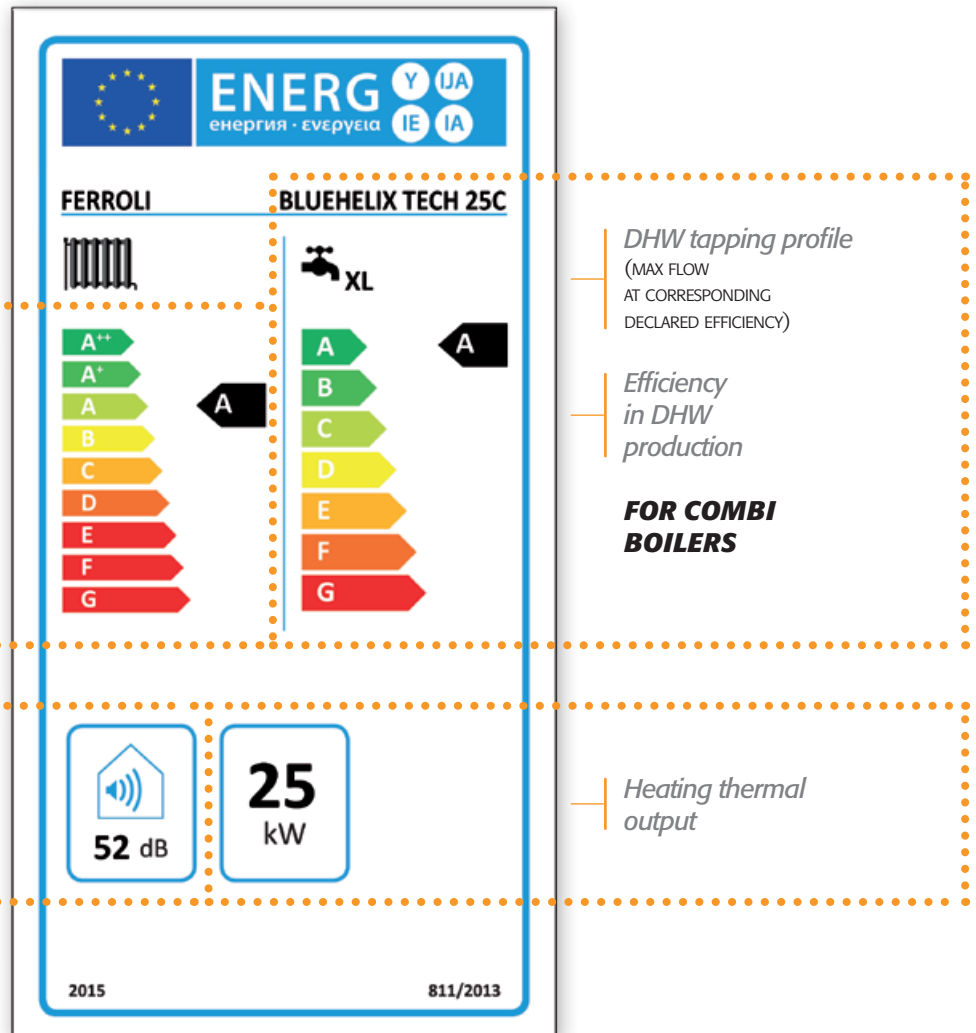

## > COMPONENTS MODEL C

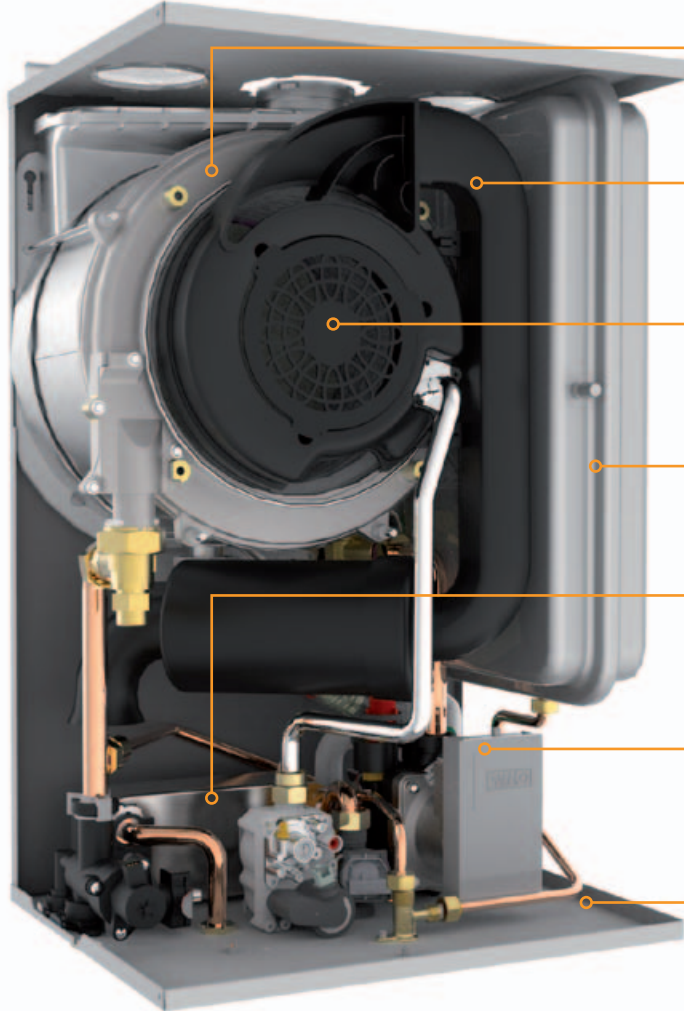

### PRIMARY HEAT EXCHANGER

Ferrol-developed, made from AISI 316 Ti stainless steel

### SILENCER

Air intake duct with built-in silencer to minimise ambient noise

### PREMIX/BURNER ASSEMBLY

Integrated fan, air/gas premixer and stainless steel burner

### EXPANSION VESSEL

8 litres for model 18 and 25, 10 litres for model 35

### SECONDARY DHW HEAT EXCHANGER

High efficiency stainless steel plate heat exchanger for domestic hot water

### MODULATING HIGH-EFFICIENCY PUMP

All models are fitted with a modulating circulating pump that can adapt boiler heat input to actual system demand

### COMPLETE INSULATION

Inner heat insulation and soundproof lining to reduce ambient noise and increase appliance thermal efficiency

MODEL C (INSTANT COMBI) INCLUDES DHW EXCHANGER, FLOWMETER AND DHW SENSOR, THAT ARE ABSENT ON HEATING MODEL (A), WHICH HOWEVER INCORPORATES DIVERTING VALVE

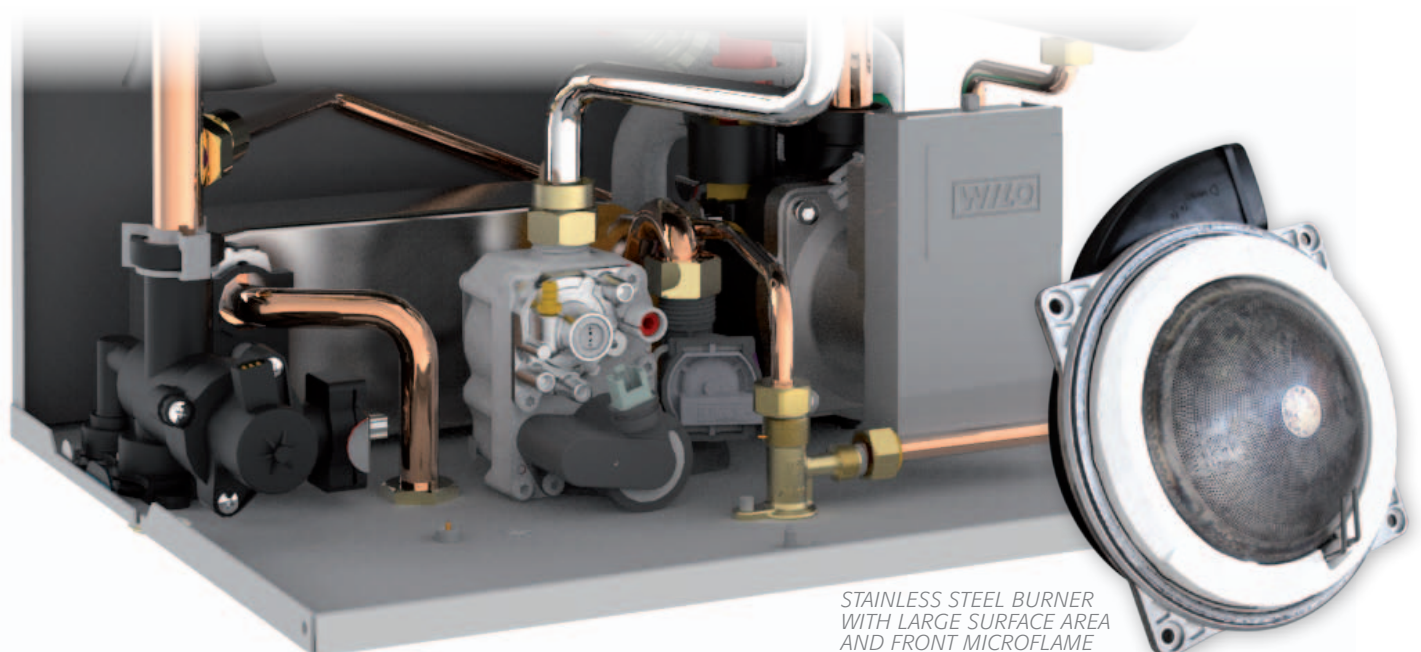

STAINLESS STEEL BURNER WITH LARGE SURFACE AREA AND FRONT MICROFLAME

## > COMPONENTS EXCHANGER

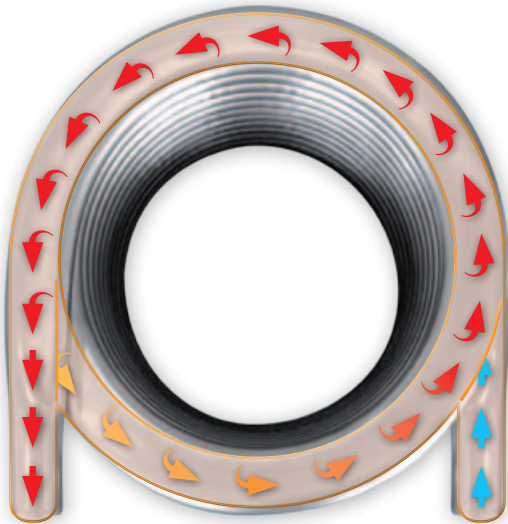

Ferrolì' research and engineering developed a heat exchanger which is simple and robust in its structure, using front-rank materials.

**STRUCTURE** Exchanger consists in a simple coil, with no joints nor weldings. The generous section of the pipes enables a free, wide transit of system water. The spiral layout hinders impurities deposit. The pipe bundle is unique, a single coil, with no further parallel circuits. As it is not a multi-coil exchanger, air bubbles cannot "hide" between the circuits' meanders. Furthermore, an eventual chemical cleaning would be carried out effectively. Cleaning pump cannot push through a free circuit rather than a clogged one indeed.

**MATERIAL** Pipe constituting Bluehelix Tech's exchanger is made in **stainless steel AISI 316 Ti**.

It is a so-called austenitic alloy, particularly resistant to corrosion, further enhanced with titanium addition. This material also permits to get an extremely smooth surface, then less exposed to encrusting agents and deposits.



## > HEATING CIRCULATION CLASS A PUMP...

Regulation 622/2012 states all boilers (among other generator of course) introduced in the market from first august 2015 shall be equipped with high efficiency circulator, also defined as "class A" pump. Such step has been taken consequent to the huge energy consumption of all pumps and circulators installed in different applications in Europe. Into practice, a high efficiency circulator - built-in the boiler - drops until **30%** of total electric consumptions of the boiler itself.



## > TOUCHABLE FACTS

- Boiler installed in a moderately cold climate
- Heating daily degrees ( $T_{in}$  20°C,  $T_{out}$  12°C):  
**2500**
- Max consumption of standard non-modulating circulator 0,085 kW, for hypothetical max yearly consumption 212,5 kW
- Max consumption of class A modulating circulator 0,04 kW, for hypothetical max yearly consumption 100 kW
- Energy cost **0,19 €/kWh**
- **Class A circulator saving 21,4 €/year**

**Saving will be however higher:** class A circulator is **modulating** indeed, further with very low consumptions at minimum power (until **3 W**). Even much more saving can be considered, if comparison is made versus a circulator of an old boiler to be replaced.

**plus** *ECONOMICAL. ECOLOGICAL. EFFICIENT.*

## ...AUTOADAPTIVE

Modulating pump offers another variable for managing of the heating system, i.e. adjustment of the flow. Some of the practical, positive effects are:

- System start up: quicker heating of the system and full monitoring of safeguard of the components heating up
- Better keeping of balance operating conditions when setpoint is reached
- Helps in limit conditions of operation (e.g. minimum output), reducing on/off fluctuations
- Prompt and energy efficient reaction to variation in system's thermal charge, for instance in multi-zones systems.

## ...ROBUST

Pump chosen for Bluehelix Tech features other qualities:

- PMW signal (pulse-width modulation) to circulator enable very quick intervention timing and is a proper completion of the evolved, watchful electronics. As a consequence burner and pump ON-OFF swings will be drastically reduced
- Electronic control of starting and pull-up torque, with consequent reduction of seizing danger. A routine anti-seize program is however carried out every 24 hours while idle
- Self-protection mode in case of overheating
- Less operating noise

What abovementioned means longer lifespan of pump, but also of components prone to wear and mechanical stress, owing to frequent on/off cycles.

## ...POWERFUL (CHECK DIAPHRAGM PUMP'S FLOW/HEAD AT THE FOLLOWING PAGES)

## > BOILER CONTROL CONTROL PANEL AND FUNCTIONS

The BLUEHELIX TECH control and management electronics allow the user to customise appliance operation and manage indoor comfort as desired. The pushbutton control panel and the simple LCD display make programming hot water production extremely easy and intuitive, both for domestic hot water and central heating.

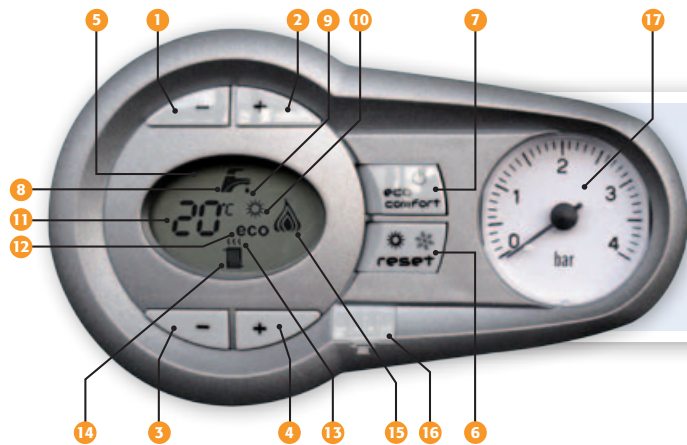

**1-2** Domestic hot water temperature control **3-4** Central heating temperature control **5** Display **6** Reset button/Summer-Winter mode selection/Temperature compensation menu **7** Economy-Comfort mode selection/Appliance on-off **8** Domestic hot water symbol **9** Domestic hot water operation indicator **10** Summer mode indicator **11** Multi-function indicator **12** Economy mode indicator **13** Heating function indicator **14** Heating symbol **15** Burner on indicator and current output level (flashing during exchanger protection function) **16** Service Tool connection **17** Pressure gauge

## > REMOTE CONTROL ROMEO: THE MODULATING COMFORT PLANNER

The BLUEHELIX TECH boiler can be used with a wide range of remote timer controls to manage appliance operation from a distance. The ROMEO series features four models, with weekly or daily comfort programming respectively and the possibility for both to choose between wired or wireless connection.



WITH ROMEO  
YOU CAN:

Set the central heating and domestic hot water temperature | Check boiler operating status | Display the temperature inside and outside the home | Restart the boiler if it temporarily shuts down | Program indoor comfort on a daily or weekly basis | Switch the central heating on or off through a phone dialer |



**ENERGY CLASS FOR PRODUCT PACKAGE A+**  
in combination with Romeo and outdoor probe

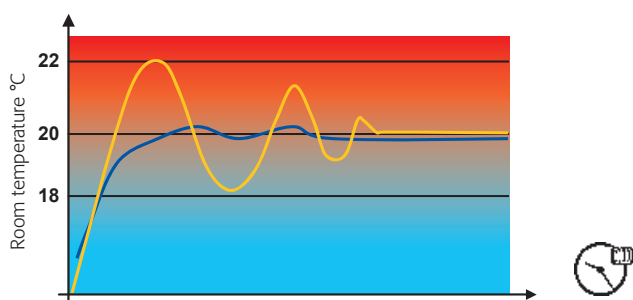

The modulating function available on ROMEO allows boiler output to be modulated progressively as it approaches the set room temperature. This improves comfort by eliminating peaks in heat output, and consequently ensures energy savings.

WITH ROMEO REMOTE CONTROL

WITH NON-MODULATING ROOM THERMOSTAT



## > **SOLAR CIRCUIT INTEGRATION** SUN EASY FUNCTION

BLUEHELIX TECH C has been designed to be easily integrated into systems developed using the latest technology. The SUN EASY system, fitted as standard on the boiler, features electronics that simplify combined use with solar collectors, with both natural and forced flow. A sensor installed in the domestic hot water circuit continuously monitors the temperature of the water coming from the solar collectors, igniting the burner only when the water temperature falls below the setpoint required to guarantee optimum comfort for the user.



## > **COMFORT AND SAFETY** FUNCTIONS

The designers have developed a series of functions that guarantee domestic hot water production quality and best delivery of power to the central heating system, combined with longer appliance life.

### > **ECO-COMFORT FUNCTION**

BLUEHELIX TECH can manage COMFORT function (also with time planning using Romeo remote control). Such function on combi model keeps DHW setpoint temperature in the plates exchanger. As a consequence domestic hot water supply is even faster and more comfortable.

In ECO operation, domestic hot water production is managed in the traditional way. In case BLUEHELIX TECH A / H is connected to a tank, tap water won't be heated with ECO mode active.

### > **TEMPERATURE COMPENSATION OPERATION**

The "outside probe" kit can be installed to operate the boiler with system flow temperature compensation. This means that without using the buttons on the system's temperature controller, the boiler automatically adapts to the variations in the outside temperature.

As a result this brings energy savings while still guaranteeing maximum comfort for the user.

### > **ANTIFROST FUNCTION**

If the temperature in the boiler falls to 5°C, the burner automatically ignites and the pump is started, so as to protect the appliance against any damage caused by frost.

This function is active when the boiler is supplied by the gas mains and powered.

## > FEATURES WATER CIRCUIT - PUMP DIAGRAMS

Mod. A (HEATING ONLY)

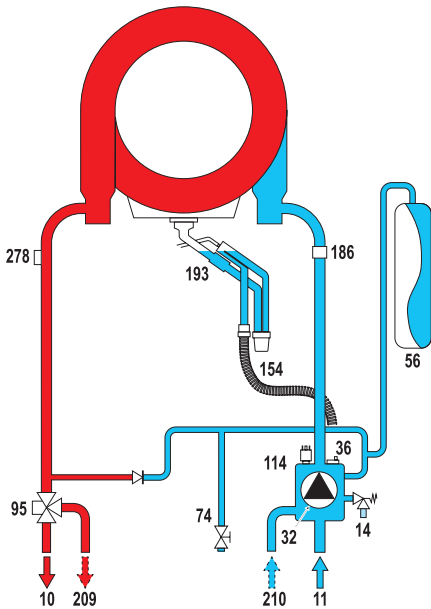

Mod. 45 H (HEATING ONLY)

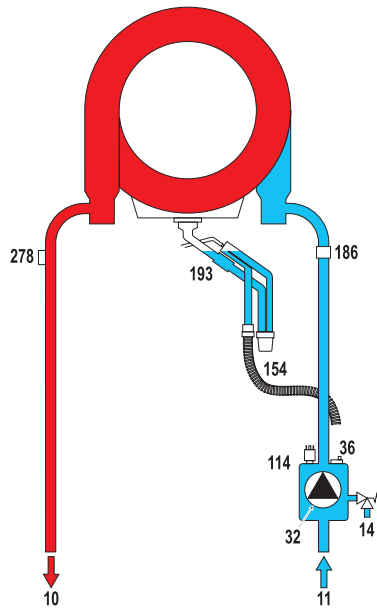

Mod. C (INSTANT COMBI)

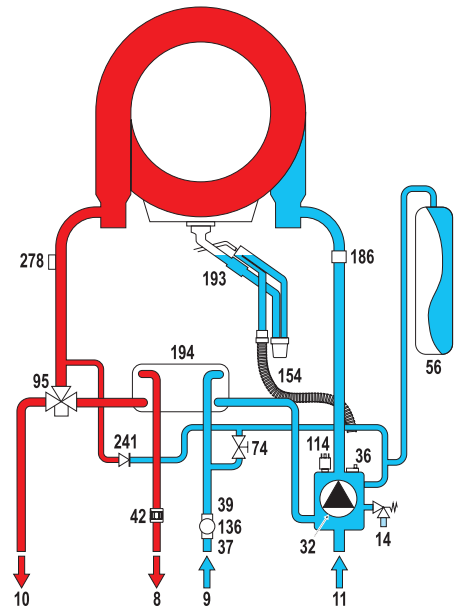

**KEY** 8 DHW water outlet 9 DHW water inlet 10 Central heating flow outlet 11 Central heating return inlet 14 Safety valve 32 Central heating pump 36 Automatic air vent 37 Cold water inlet filter 39 Water flow limiter 42 DHW temperature probe 56 Expansion vessel 74 Fill valve 95 Selector valve 114 Water pressure switch 136 Flow meter 154 Condensate drain hose 186 Return sensor 193 Drain trap 194 Domestic hot water heat exchanger 209 DHW tank flow 210 DHW tank return 241 Automatic bypass 278 Double sensor (Safety + Heating)

> BLUEHELIX TECH 18 - 25

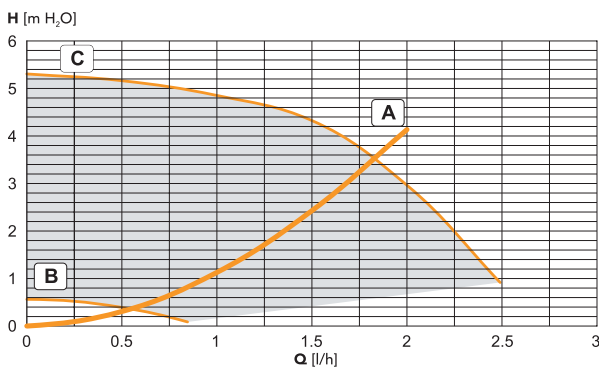

> BLUEHELIX TECH 45

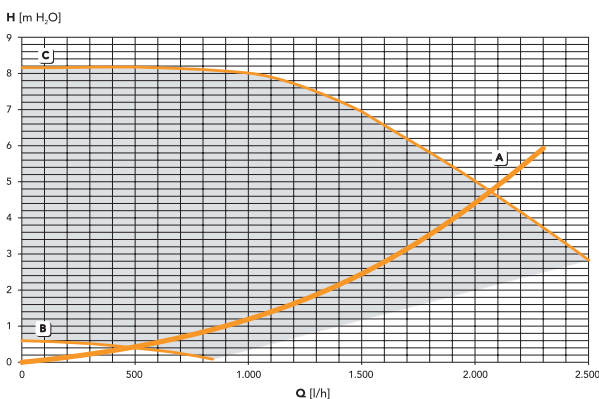

> BLUEHELIX TECH 35

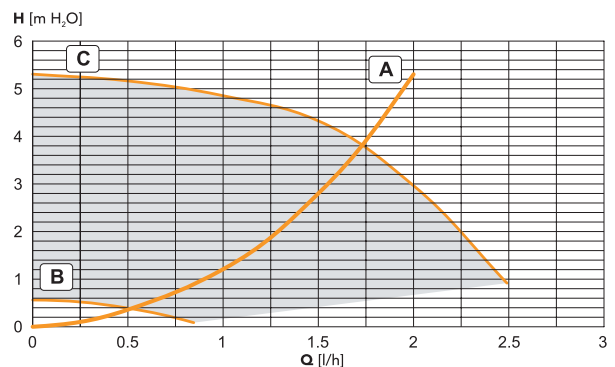

(For all schemes)

A Boiler pressure drop  
B - C Pump speed (Min - Max)

## > TECHNICAL SPECIFICATIONS

### DIMENSIONS - TECHNICAL DATA

#### BLUEHELIX TECH

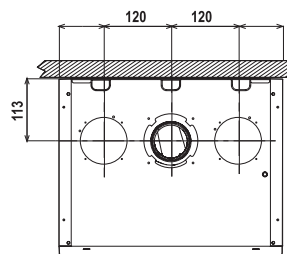
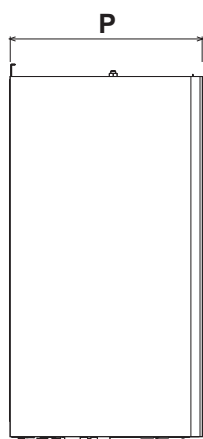
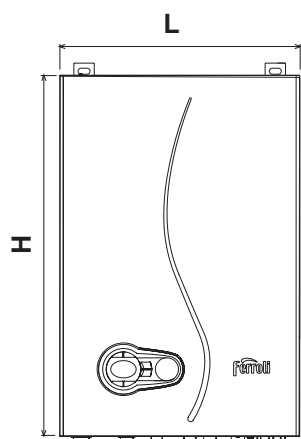

Top view  
TECH (all models)

BLUEHELIX TECH	H	L	P
18 - 25 - 35	600	400	320
45	700	420	320

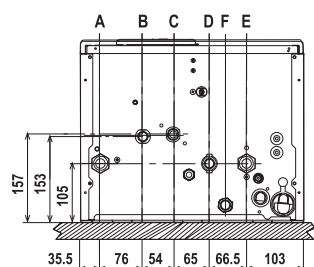

Bottom view  
TECH A

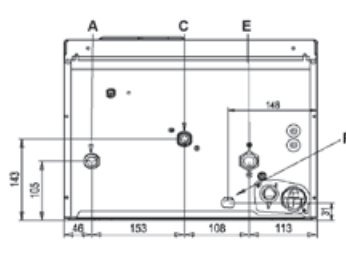

Bottom view  
TECH H

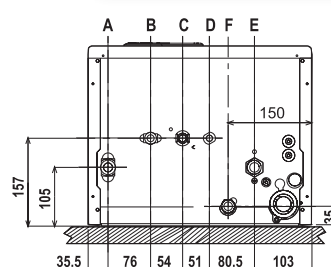

Bottom view  
TECH C

#### KEY

**A** central heating flow outlet 3/4" dia. **B** DHW water outlet 1/2" dia. (tank delivery - mod. A-H) **C** gas inlet 1/2" dia. **D** DHW water inlet 1/2" dia. (tank return - mod. A-H) **E** central heating return inlet 3/4" dia. **F** safety valve

MODELLO			18 A	25 A	25 C	35 A	35 C	45 H
ERP class			<b>A</b>	<b>A</b>	<b>A</b>	<b>A</b>	<b>A</b>	<b>A</b>
			-	-	<b>XL A</b>	-	<b>XXL A</b>	-
Seasonal efficiency		$\eta_s$ %	<b>93</b>	<b>94</b>	<b>94</b>	<b>94</b>	<b>94</b>	<b>93</b>
Thermal input	Min	kW	4,0	5,8	5,8	6,7	6,7	7,5
	Max Heating	kW	17,4	25,0	25,0	34,8	32,0	43,0
	Max DHW	kW	-	-	27,5	-	34,8	-
Thermal output 80°C-60°C 50°C-30°C	Min	kW	3,9	5,7	5,7	6,6	6,6	7,3
	Max Heating	kW	17,0	24,5	24,5	34,1	31,4	42,1
	Max DHW	kW	-	-	27,0	-	34,1	-
	Min	kW	4,3	6,2	6,2	7,2	7,2	8,0
	Max Heating	kW	18,5	26,5	26,5	36,9	34,0	45,6
	Useful thermal efficiency	80°C-60°C	Pmax %	98,0	98,0	98,0	98,0	98,0
Pmin %			97,8	97,8	97,8	97,8	97,8	97,8
50°C-30°C		Pmax %	106,1	106,1	106,1	106,1	106,1	106,1
		Pmin %	107,5	107,5	107,5	107,5	107,5	107,5
Reduced load 30%		Pmax %	108,8	108,8	108,8	108,8	108,8	108,8
Domestic hot water production	$\Delta t$ 30°C	l/min	-	-	12,9	-	16,3	-
	$\Delta t$ 25°C	l/min	-	-	15,5	-	19,5	-
Central heating operating pressure	Max	bar	3	3	3	3	3	4,5
	Min	bar	0,8	0,8	0,8	0,8	0,8	0,8
Empty weight		kg	28	28	29	30	31,5	30



**NOTICE FOR DEALERS:**

As part of its efforts to constantly improve its range of products, with the aim of increasing the level of customer satisfaction, the company stresses that the appearance, dimensions, technical data and accessories may be subject to variation.

Consequently, ensure that the customer is provided with up-to-date technical and/or sales documents.

**Ferrolì spa**

37047 San Bonifacio (VR) Italy - Via Ritonda 78/A

tel. +39.045.6139411

fax +39.045.6100233

[www.ferrolì.com](http://www.ferrolì.com) - [export@ferrolì.it](mailto:export@ferrolì.it)